

Cibēs



NEW GENERATION  
**HOME LIFT**

# CIBES – SINCE 1947

Cibes Lift Group is one of the world's largest manufacturers of low-speed lifts, with sales and distribution in more than 70 countries, and a network of 200+ certified distributors.

WHAT MAKES CIBES SPECIAL?

## DIRECT SALES ACROSS THE WORLD

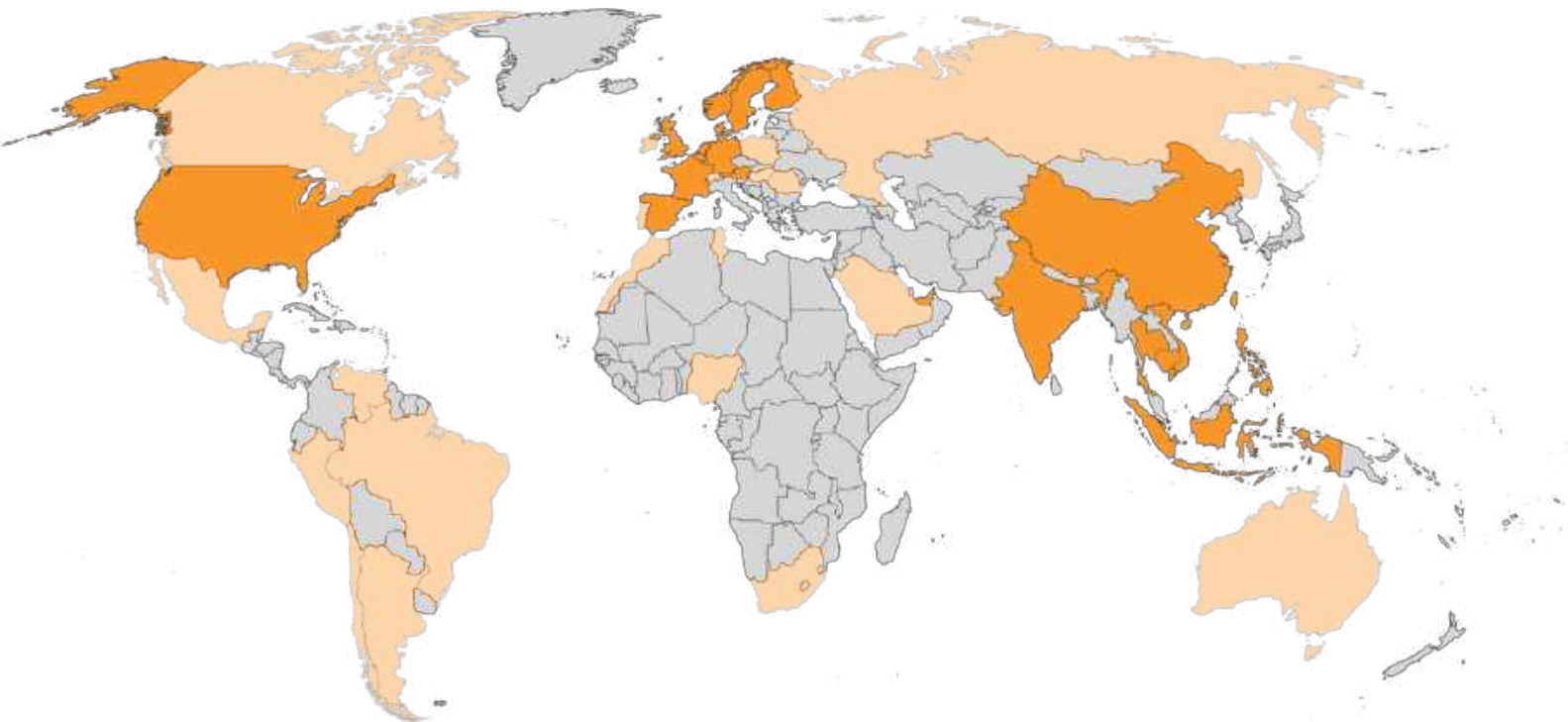

### FACTORY DIRECT SUBSIDIARIES IN:

SWEDEN | NORWAY | FINLAND | FRANCE | UNITED KINGDOM | GERMANY | HOLLAND | SPAIN | AUSTRIA | BELGIUM | DUBAI | CHINA | VIETNAM | THAILAND | **PHILIPPINES** | INDONESIA | CAMBODIA | | INDIA | USA

### CIBES DIRECT OWNED FACTORIES

Gävle, SE | Jiaxing, CN | Roanoke, USA

### APPROVED DEALERS IN:

70+ Countries

WORDS FROM OUR CEO,  
**PER LIDSTRÖM**



One does not build a company that lasts over 70 years without an unwavering commitment to customer satisfaction. Cibes fully embraces the Scandinavian ethos of reliability, which is why we are uncompromising when it comes to the quality of our products, the elegance of our designs and our commitment to safety. From the start, our best marketing has always been our existing customers, and the 50,000 lifts we have installed around the world continue to be a driver of our success. At Cibes, we know that our happy customers are the key to our longevity, and we look forward to having you join the Cibes family!

*Per Lidström*

CEO, CIBES LIFT GROUP

ABOUT

## CIBES LIFT GROUP IN 2022

**290**

**MILLION EUROS**

In turnover in 2021

**1,635**

**EMPLOYEES**

Across the world

**100,000+**

**LIFTS INSTALLED**

In 70+ countries



# SPACE - SAVING TECHNOLOGY

## NO MACHINE ROOM

Minimize civil works and able to open up on last floor without damage to roof area

## ALL GLASS SHAFT

Able to do 360 glass shaft for a panoramic ride

## SUPERIOR QUALITY

From our glass (laminated and tempered) to our shaft (aviation grade aluminum with premium custom powdercoat), every detail of our lift is carefully studied to offer the best quality.

## CABIN DESIGN

Our lifts are platform lifts, which saves space, creates a feeling of openness and avoids locking you inside a cabin.

## NO PIT

Our lift requires no pit - as low as 0 mm and maximum 100 mm. Easy to install anywhere!

## SCREW DRIVE SYSTEM

Your lift is always attached to our screw and cannot "fall down".  
Silent and energy efficient

## TOUCH AND LIGHT

Our Cibes lifts come with full touchscreen to offer a modern design that can match any interior

## ANTI-STUCK SYSTEM

Battery back up, reset tag on door, phone and emergency openings – we have you covered even if the worst were to happen!





# HISTORY OF SCREW - DRIVE SCREW-DRIVE GENERATIONS



4<sup>th</sup> GENERATION  
**ECOSILENT 2.0**

- **Reduced oil use:** no oil on guiderails, auto-lubricating system on screw, >200 mL of oil / year!
- **More energy savings:** 1.5 kW motor
- **Silent operation:** new screw pitch and silent box for sound as low as 40 dB
- **Reduced maintenance:** as low as once per year

Includes all  
2<sup>nd</sup> Generation / Smart Lift features



2<sup>nd</sup> GENERATION  
**SMART LIFT**

- **Mechanical System:** all functions were mechanical and not driven by software
- **Lower Travel Height:** 13 m

1<sup>st</sup> generation lifts were **discontinued** in 2017 for all Cibes Lift Group products

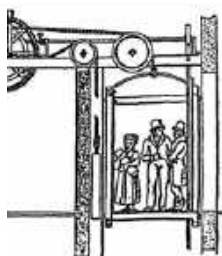

1<sup>st</sup> SCREW-DRIVE  
**ELEVATOR**

2022

- **Even Safer Lift!** – light curtain upgrade for safety edges for near-instantaneous stops, 2N dialer to ensure always functional phone
- **Even Smoother Ride** – Upgraded XXL rollers for an ultra smooth guiderail connection
- **Connected Lift** – connected to our Cibes Control Center for monitoring and remote assistance if needed

Includes all  
2<sup>nd</sup> Generation / Smart Lift features



3<sup>rd</sup> GENERATION  
**ECOSILENT**

- **Smart Operating System:** digital OS (i.e. software)
- **Safer Lift** – thanks to our CiCon System, our lift can be SIL-3 certified, the second highest Safety Integrity Level there is
- **Reset RFID Tag** – you can reset the lift yourself – no need to wait for one of our technicians
- **Warning Systems:** e.g. low battery system
- **Fault and Breakage Record:** keeps track of all key metrics e.g. travel distance, number of faults and reason to help improve repairs
- **Higher Travel height:** from 13 to 20 m!
- **Advanced Features:** e.g. floor specific locks

2019

2017

1990s



1<sup>st</sup> GENERATION  
**MECHANICAL**

1793

Invented for the Russian empress Catherine the Great by inventor Ivan Kulibin, the 1<sup>st</sup> screw drive elevator was installed in the imperial palace The Hermitage in St. Petersburg

SAFETY IS IN OUR DNA

# SWEDISH FOCUS ON QUALITY

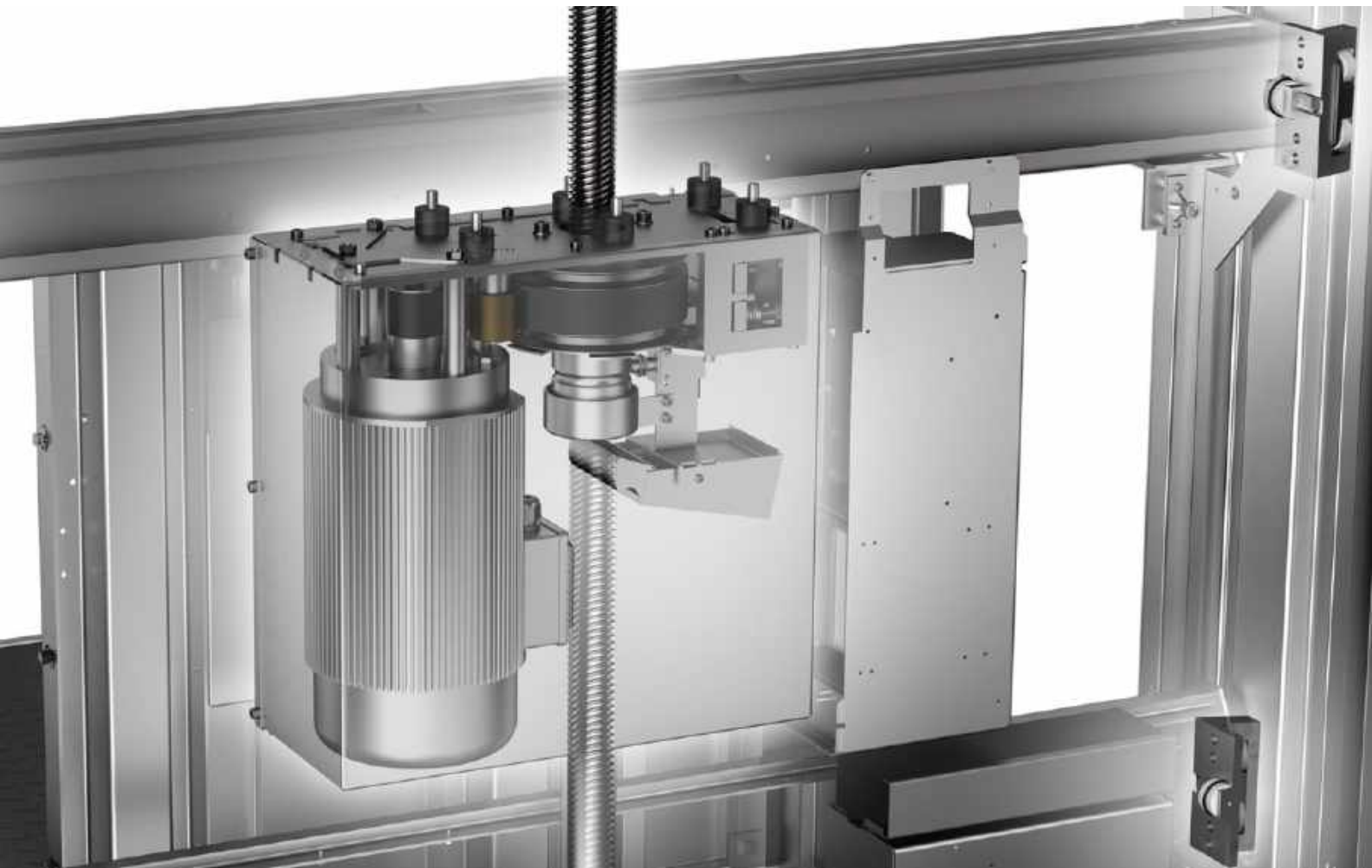

SCREW DRIVE TECHNOLOGY:

## LIFTS THAT CANNOT “FALL DOWN”

Screw-drive technology is unique in the market in that the lifting cabin or platform is always attached to a toughened steel screw. The movement behind the “lifting” is not a pulling motion through cable or belt, but a rotation of a nut around the screw.

This revolutionary system ensures that Cibes Lift platforms and cabin cannot be “cut off” or enter freefall because of cable and brake failures. Instead, they are always connected to the steel screw that runs the length of the whole device.

Thanks to this technology, our screw drives are able to meet not only the extremely high European Safety Standards but also those of our other markets around the world, including but not limited to the USA and Australia.

# WHY CUSTOMERS CHOOSE CIBES

## OUR SAFETY STANDARDS



### STANDARDS

All our lifts not only follow the strictest of European and international standards, but we even strive to respect recommended local standards in each of our markets.



### SAFETY CERTIFICATIONS

Beyond certifying every lift with the European Lift Instituut, a certification agency specialized in lifts, all our lifts are **Safety Level Integrity 3** certified and our production **ISO 9001**



### NATIONWIDE, 24/7 COVERAGE

We may be a global company, but we are hyperlocal for our customers. Our hotline is 24/7, with technicians spread across the country. We are there anytime, anywhere.



### ANTI-TRAP SYSTEM FOR EMERGENCIES

All our lifts are equipped not only with an emergency battery lowering system in case of power failures, but also a reset system. Gen 4 also has manual lowering in pit!



### LIGHT CURTAIN FOR LASER-FAST SAFETY

The combination of Cibes light curtain to stop near instantaneously in emergency situations, and the cabin design of our V70 / V90 allows us to reach a new level of safety.



### INTERNET CONNECTED LIFTS - CIBES MONITORING CENTER

Our newest generation of lifts can connect to the internet for monitoring by our system, allowing us to better plan preventative maintenances and improve support!



WHY CUSTOMERS CHOOSE CIBES

# MEET OUR CUSTOMER CARE TEAM



All our customers agree – the main reason to choose a Cibes lift is not our cutting-edge products or our expert sales team – **it is the quality of our After Sales Service.**

As soon as you book your lift with us, you will be entrusted to our Customer Care team with your appointed representative. They will ensure that:

#### **BEFORE INSTALLATION**

- Liaising with your construction team to prepare site & delivery
- Checking that site is correctly prepared and ready for installation

#### **AFTER INSTALLATION**

- Checking that installation is in line with our strict quality standards
- Delivering handover and product training on how to use your lift

#### **... AND FOR THE DECADES TO COME**

- Tracking and arranging timely maintenances
- Coordinating repairs, spare parts & fixes (if needed)
- Handling any customer requests / upgrades and more!

*Prang – Head of Customer Care*

*How do we know that our customers love our Customer Care Team?*

**Referrals are 35% of our new business!**



# CIBES 2 + 2 + 10 PROGRAM

So confident are we in the quality of our products that we offer a comprehensive 2+2+10 product guarantee.

## 2 YEARS OF FREE WARRANTY

The only thing more stressful than buying a lift is probably worrying about repairs and problems.

With Cibes, that worry does not exist.

We know that the quality of our materials, craftsmanship and installation creates a one-of-a-kind lift that will last for decades.

In fact, we are even willing to guarantee it, with a FREE 2 year warranty for every single V70 Cibes Lift that we sell.

Welcome to a new level of worry-free living. Welcome to the Cibes family!

## 2 YEARS OF FREE MAINTENANCE

Even more important than the warranty is the hidden cost of maintenance. With Cibes, there are no hidden costs: we offer 2 years of maintenance for FREE to every single V70 Cibes Lift.

No last-minute additions for labor or spare parts – at Cibes, we want to provide our customers with complete peace of mind.

Most importantly, a Cibes maintenance is no small thing: we only use genuine Cibes Technology™ products, included Cibes Genuine High Performance Oil and Cibes Universal Contact Spray, to ensure that your lift continues to operate smoothly for decades!

## 10 YEARS OF FREE WARRANTY



on the Cibes Lift Screw & Nut, conditional to doing maintenances with Cibes Team timely throughout this period



OUR PRODUCT RANGE

# GLASS SHAFT (V-Series)



**V80**  
PLATFORM



**V90**  
CABIN

TIER I  
**ELEGANCE**



TIER II  
**AURORA**



TIER III  
**GALAXY**





OUR PRODUCT RANGE

# V70 SHAFTLESS Series



TIER I  
**ELEGANCE**



TIER II  
**AURORA**

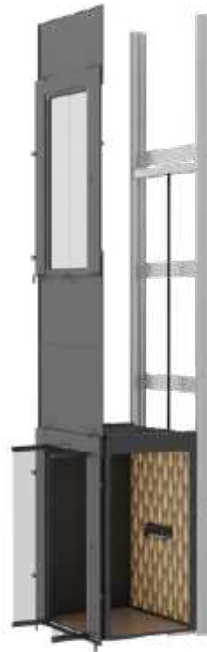

TIER III  
**GALAXY**





**CHOOSE YOUR TIER  
ELEGANCE / AURORA / GALAXY**





TIER I  
**ELEGANCE**



TIER II  
**AURORA**



TIER II  
**AURORA**



TIER III  
**GALAXY**



TIER I

# ELEGANCE



**RECESSED LIGHTING**



**SWING OR SALOON DOORS**



**WHITE WOOD HPL PANEL**



**GREY IRON FORBO FLOORING**



**TOUCHSCREEN CONTROL PANEL**



**TOUCHSCREEN CALL BUTTON**



## ELEGANCE MODELS



**V80**  
ELEGANCE

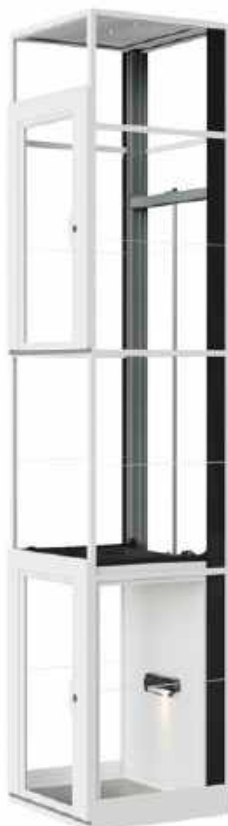

**V90**  
ELEGANCE



**V70**  
ELEGANCE

TIER II

# AURORA

## PREMIUM POWDER COATS



ORGANIC SIGNAL  
WHITE

ORIENTAL OYSTER  
WHITE

ORIENTAL GREY  
BEIGE

ORIENTAL PALE  
BROWN

GOthic GRAPHITE  
BLACK

GLACIAL SLATE  
GREY

## HPL WALLS



SMOKE STRAND  
STRAIGHT

BLACK WALNUT

BLACKEN LEGNO  
PARTIAL CROWN

TRAVERTINE  
SILVER

JET SEQUOIA



RECESSED CEILING



SWING OR SALOON



STONE FINISH FLOORING



TOUCHSCREEN CONTROL PANEL



TOUCH CALL BUTTON



## AURORA MODELS



**V80**  
AURORA



**V90**  
AURORA

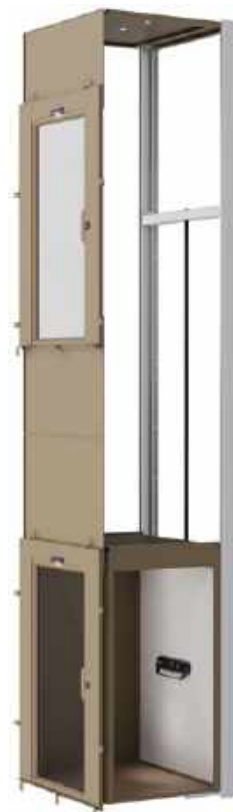

**V70**  
AURORA



TIER II

# AURORA

## LIGHT UP MOOD WALLS



EVENING AGATE



IONA

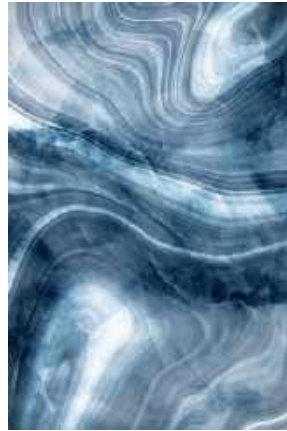

COBALT BLUE



PHARAOH



NOVA CLOUDS



INCA



CINNABAR ROSE



PAVONA FEATHERS



LONG SPRING



IMPERIAL BLACK

## PREMIUM POWDER COATS



ORGANIC SIGNAL WHITE



ORIENTAL OYSTER WHITE



ORIENTAL GREY BEIGE



ORIENTAL PALE BROWN



GOthic GRAPHITE BLACK



GLACIAL SLATE GREY



TOUCHSCREEN CONTROL PANEL



TOUCH CALL BUTTON



## AURORA MODELS



**V80**  
AURORA



**V90**  
AURORA

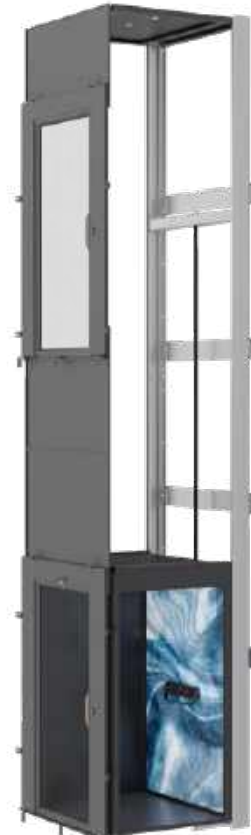

**V70**  
AURORA

TIER III

# GALAXY

LASER ETCHED LIT PATTERN

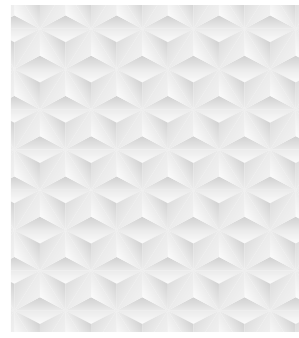

ORIGAMI

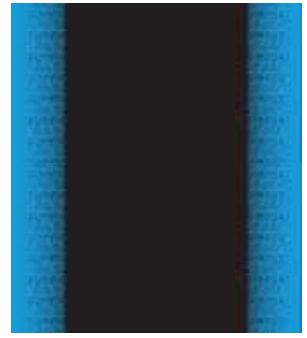

AWAKENING



PINE FOREST



NEON JAZZ



ARCTIC ICE



NEBULA



BASILICA LIGHTS

PREMIUM POWDER COATS



JANUARY 4



QUARTZ 1



QUARTZ 2



FEBRUARY 5

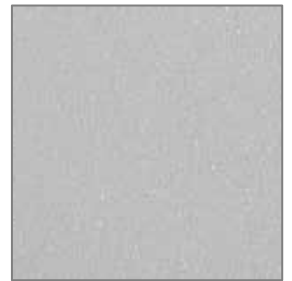

FEBRUARY 6



RGBW LIGHT LIGHTING



SWING OR SALOON



STONE FINISH FLOORING



PREMIUM TOUCHSCREEN



ANIMATED CALL BUTTON





## GALAXY MODELS



**V80**  
GALAXY



**V90**  
GALAXY

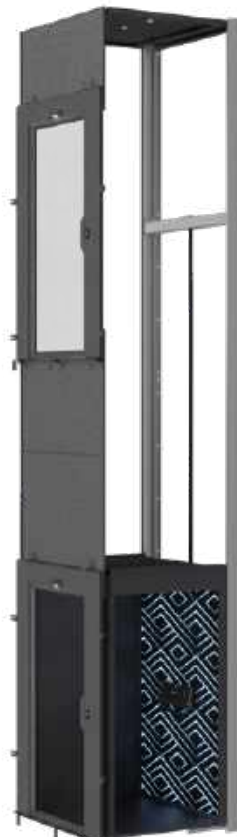

**V70**  
GALAXY

## SIZE SUMMARY

	SIZE SUMMARY							
	CABIN SIZE (V70 & V90) (in mm)		PLATFORM SIZE (V80) (in mm)		SHAFT SIZE (in mm)		Cut-Out Size (add +30 mm on adjacent side to door)	
	A/C Side	B/D Side	A/C Side	B/D Side	A/C Side	B/D Side	A/C Side	B/D Side
1	710	815	635	850	1000	900	1040	940
2	810	815	735	850	1100	900	1140	940
3	910	815	835	850	1200	900	1240	940
4	1010	815	935	850	1300	900	1340	940
5	1110	815	1035	850	1400	900	1440	940
6	1210	815	1135	850	1500	900	1540	940
7	710	915	635	950	1000	1000	1040	1040
8	810	915	735	950	1100	1000	1140	1040
9	910	915	835	950	1200	1000	1240	1040
10	1010	915	935	950	1300	1000	1340	1040
11	1110	915	1035	950	1400	1000	1440	1040
12	1210	915	1135	950	1500	1000	1540	1040
13	710	1015	635	1050	1000	1100	1040	1140
14	810	1015	735	1050	1100	1100	1140	1140
15	910	1015	835	1050	1200	1100	1240	1140
16	1010	1015	935	1050	1300	1100	1340	1140
17	1110	1015	1035	1050	1400	1100	1440	1140
18	1210	1015	1135	1050	1500	1100	1540	1140
19	710	1115	635	1150	1000	1200	1040	1240
20	810	1115	735	1150	1100	1200	1140	1240
21	910	1115	835	1150	1200	1200	1240	1240
22	1010	1115	935	1150	1300	1200	1340	1240
23	1110	1115	1035	1150	1400	1200	1440	1240
24	1210	1115	1135	1150	1500	1200	1540	1240
25	710	1215	635	1250	1000	1300	1040	1340
26	810	1215	735	1250	1100	1300	1140	1340
27	910	1215	835	1250	1200	1300	1240	1340
28	1010	1215	935	1250	1300	1300	1340	1340
29	1110	1215	1035	1250	1400	1300	1440	1340
30	1210	1215	1135	1250	1500	1300	1540	1340
31	710	1315	635	1350	1000	1400	1040	1440
32	810	1315	735	1350	1100	1400	1140	1440
33	910	1315	835	1350	1200	1400	1240	1440
34	1010	1315	935	1350	1300	1400	1340	1440
35	1110	1315	1035	1350	1400	1400	1440	1440
36	1210	1315	1135	1350	1500	1400	1540	1440
37	710	1415	635	1450	1000	1500	1040	1540
38	810	1415	735	1450	1100	1500	1140	1540
39	910	1415	835	1450	1200	1500	1240	1540
40	1010	1415	935	1450	1300	1500	1340	1540
41	1110	1415	1035	1450	1400	1500	1440	1540

### HOW TO UNDERSTAND THE NUMBERS

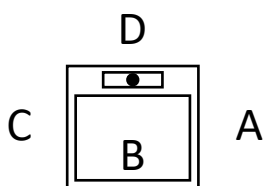

B & D are parallel to the screw and motor

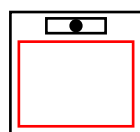

**CABIN SIZE** is the standing space inside the lift

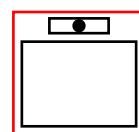

**SHAFT SIZE** is the final size of the installed shaft

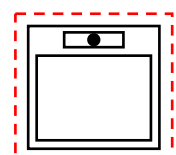

**CUT OUT SIZE** is the space needed to install the lift

# TECHNICAL SPECIFICATIONS

# TECHNICAL DETAILS

	Cabin ( 70 / 90 )	Platform ( 80 )
MAX # OF STOPS	6 Stops	
MAX TRAVEL HEIGHT	20,000 mm	
POWER SUPPLY	1 phase 220V / 3 phase 220 V / 3 phase 400 V	
MINIMUM HEIGHT TOP FLOOR	2500 mm	2250 mm
BOTTOM PIT	100 - 120 mm / 0 mm optional with ramp	50 - 70 mm / 0 mm optional with ramp
PRODUCT STANDARD	MD 2006/42/EC, EN81-41, certified by SIL3	
DRIVE MODE	Screw-Drive	
RATED POWER	3 kW	
MACHINE ROOM	None (integrated solution)	
DOOR OPENING	One Side Only	Flexible choice for 3 sides
SAFETY DEVICE	360° catchment protection with light curtain. Emergency Battery Lowering in case of power failure. Overload alarm device. 2N phone-equipped emergency communication device. Electronic and mechanical safety door protection system. Can be connected to fire alarm device.	360° catchment protection with mechanical safety edge. Emergency Battery Lowering in case of power failure. Overload alarm device. 2N phone-equipped emergency communication device. Electronic and mechanical safety door protection system. Can be connected to fire alarm device.
SHAFT OPTION	Shaftless (V70) / Panoramic (V90)	Panoramic (V80)
LOCATION	Indoor or Outdoor	
SPEED	0.15 m/s / 0.25 m/s	0.15 m/s
GLASS	Tempered & Laminated	



## WHAT ABOUT SPEED?

# 0.15

Our standard and recommended speed for optimal operation.

0.15 m/s is the speed that is recommended by the EU En81-41 machine directive for our range of platform lifts, which we also extend to our full range of products.

# 0.25

Thanks to our cabin design and light curtain safety edges, we are able to offer a faster speed of 0.25 exclusively on the V70 / V90 line when using 3-phase power without compromising safety in any way.

Enjoy a faster ride in full safety!



A NEW TYPE OF COP

# TOUCHSCREEN LUXURY

## ALARM BUTTON & PHONE

Press this for 10 seconds and your lift will automatically begin calling our hotline and your emergency numbers

## ANIMATED MOVEMENT

Numbers move and change in size as your lift goes from floor to floor

## EMERGENCY STOP BUTTON

Need to stop your lift for whatever reason? Press this wonderful light-up and metallic button, and your lift will come to an immediate halt

## CHROME FINISH

Available on Galaxy Tier only, the Chrome finish adds luxury and prestige to the COP

## LEATHER FINISH

With our leather finish on the handle, enjoy a refined riding experience like no other

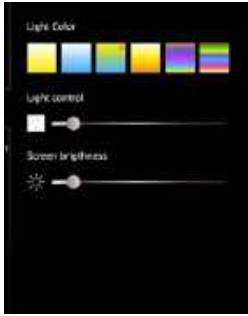

### LIGHT CONTROL

Control everything from the color and the brightness of the lights to the brightness of the touchscreen itself. Switch between recommended lighting schemes!



### PARENTAL CONTROL

Set-up, activate or deactivate a child lock for your lift with a special PIN



### FAN CONTROL

Switch on / off or adjust the intensity of the fan directly on the COP

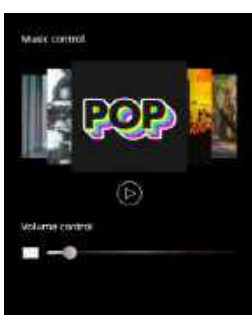

### MUSIC SELECTION

Ride in style by listening to our selection of songs pre-loaded onto your COP!



### ABOUT MY LIFT

Get information about your lift such as date of next maintenance, and distance travelled!

OUR KEY DIFFERENCE

# EXCEPTIONAL AFTER-SALES



## THE FACTORY-DIRECT AFTER-SALES PROMISE

Cibes Lift Philippines Inc. knows that the secret to its phenomenal success has been its best-in-class after-sales service. Over 35% of our business comes from referrals. This is because Cibes has focused on a factory-direct strategy for its technical team as well:

- NO OUTSOURCING!
- TECHNICIANS TRAINED FROM SWEDEN
- LOCAL SPARE PARTS WAREHOUSE

### OUR AFTERSALES IN THE PHILIPPINES

#### AFTER SALES TEAM



Mylen Teresa Benigno Warly Jeric

#### POST SALES TEAM



Rosalie Renalyn Dessa Chito

#### TECH TEAM



Dave Jose Arlan Eric Elmer  
Jeff Recto Roldan Frank Lexcil  
Melkim Jhon Paul Jay Dennis Angelo

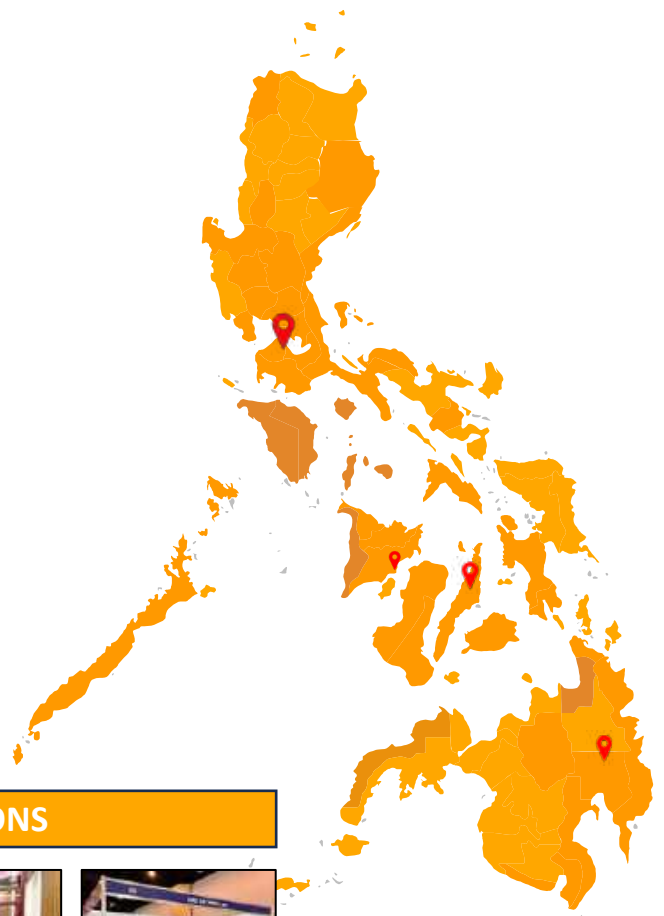

### SHOWROOMS & TECHNICAL STATIONS



MAKATI MANDALUYONG CEBU DAVAO ILOILO

NATIONWIDE  
COVERAGE



CIBES PRODUCTION UNITS

# DIRECT CONTROLLED

*"It doesn't matter whether a Cibes is made in Sweden, the USA or China – all follow our extremely strict Swedish guidelines and conform to the toughest safety standards!"*

**Chief Operating Officer**  
**Samson Popowitz**

*In charge of Gävle, Roanoke and Jiaxing Production Units*



## GÄVLE, SWEDEN

Opened in 2012, Gävle is our historic factory mostly focused on public and commercial accessibility lifts. It holds our R&D department and our QC.



**FACTORY DIRECTOR:**



**Johan Wangberg**  
Head of Production  
Gävle

## JIAXING, CHINA

Opened in 2020, Jiaxing is our state-of-the-art facility that produces high-end customized home lifts. It holds an Asia R&D center and training facility.



**FACTORY DIRECTOR:**



**Juan Trespalacios**  
Head of Production  
Jiaxing

## ROANOKE, USA

Established in 2014, our Roanoke facility produces lifts designed for the US and Latin America markets that follow the specific ASME standard



**FACTORY DIRECTOR:**



**Rick Crane**  
Head of Production  
Roanoke



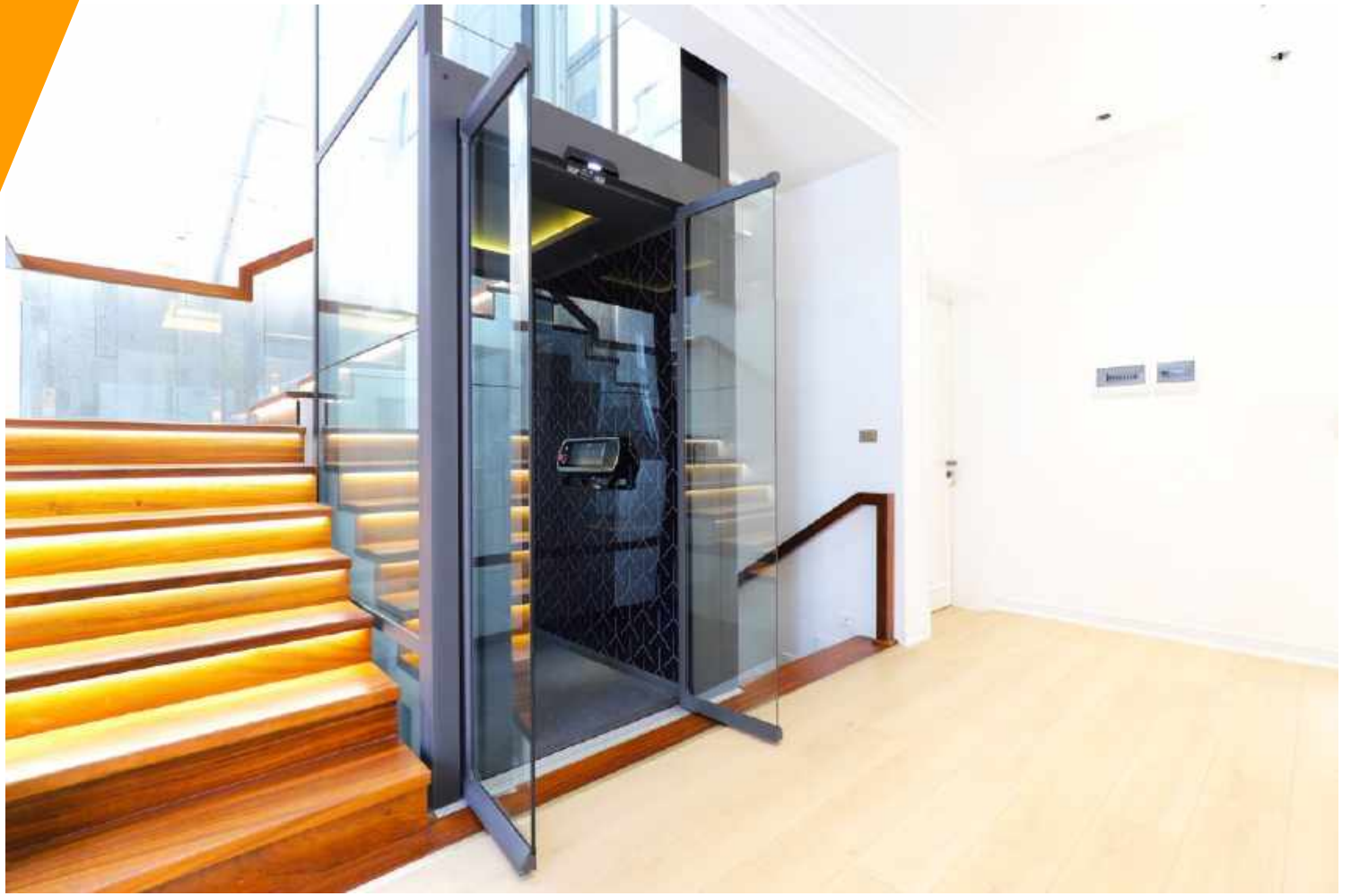

MIDDLE OF THE STAIRS



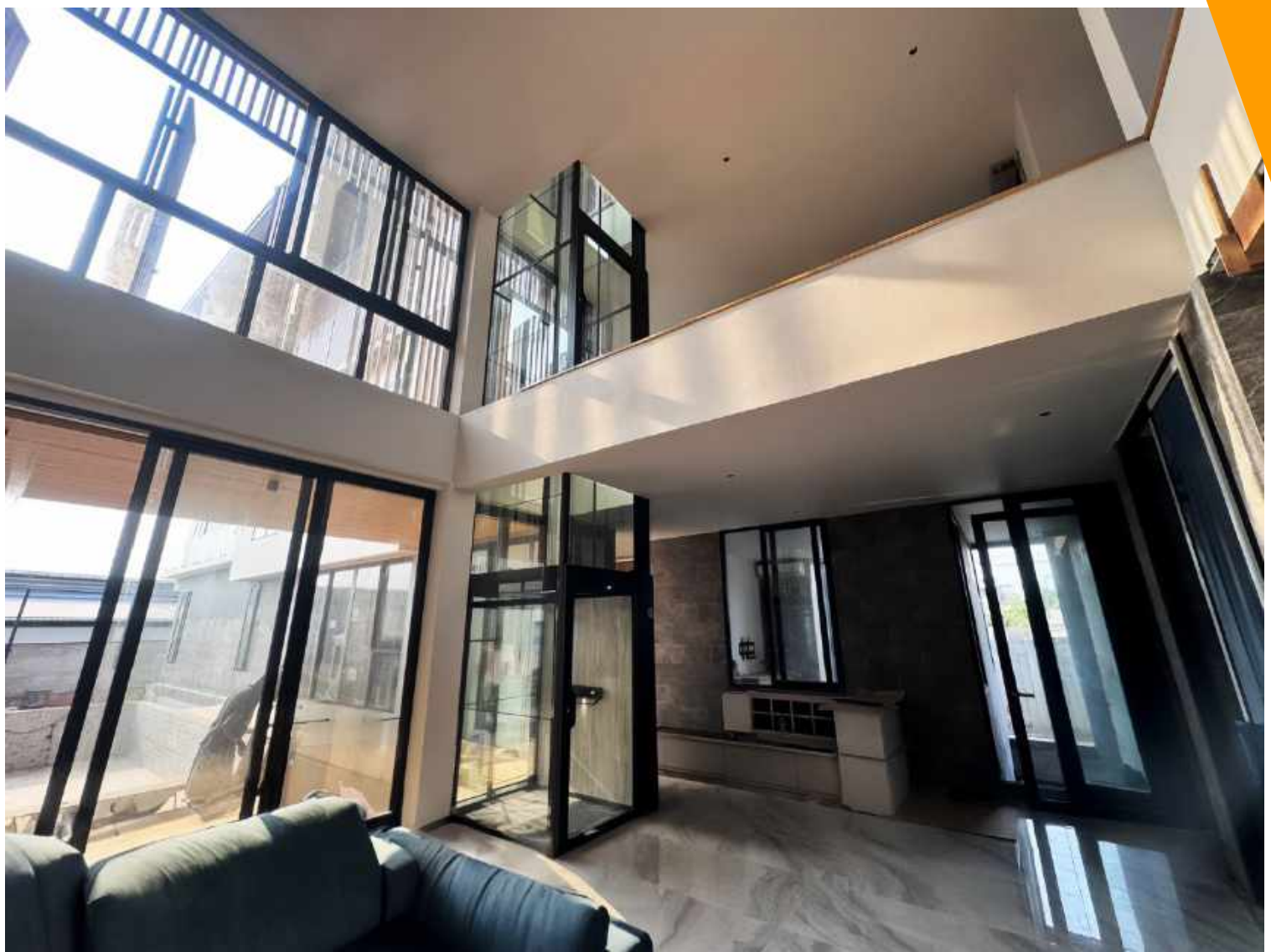

THROUGH THE FLOOR, ROOFTOP,  
GATE TYPE LIFT





OUTDOOR





IN A SHAFT

Ciběš