

ASCENDA

by Ciběs



CUTTING EDGE TECHNOLOGY

THE ASCENDA

INNOVATIVE HATCH SYSTEM

When the elevator descends to the lower stop, a hatch slides into your upper floor to cover the hole and allow you to walk around your space freely with no risk.

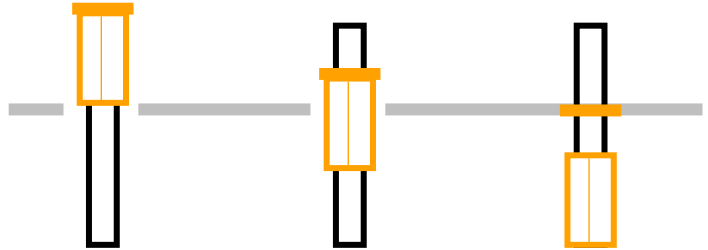

HANDRAIL CONTROL & BUILT-IN SEAT

Travel in full comfort by using the buttons on the handrail to control the lift. Pop down the seat to rest while you travel between floors!

FULLY ENCLOSED CABIN

Our beautiful glass saloon doors fully enclose you in a cabin. With zero risk of catchment, our elevator is safe for children, pets, and more!

SAFETY PAN

Should anything come beneath the elevator as it lowers, the moment it touches the safety plate, the elevator will automatically stop.

ECOSILENT SCREW DRIVE SYSTEM

Our fully enclosed glass tower will fit wonderfully inside any home. It holds our EcoSilent screw-drive technology, which runs with minimal electrical consumption and cannot "fall down" as the cabin is always attached to the screw!

EMERGENCY BATTERY LOWERING

In case of a power cut, don't you worry! The elevator will automatically enter battery mode, lower you to the bottom floor, and open the doors.

MANUAL LOWERING SYSTEM

We are all about redundancies, and this one is no exception. If all else fails, you can always lower the cabin manually yourself using our MLS.

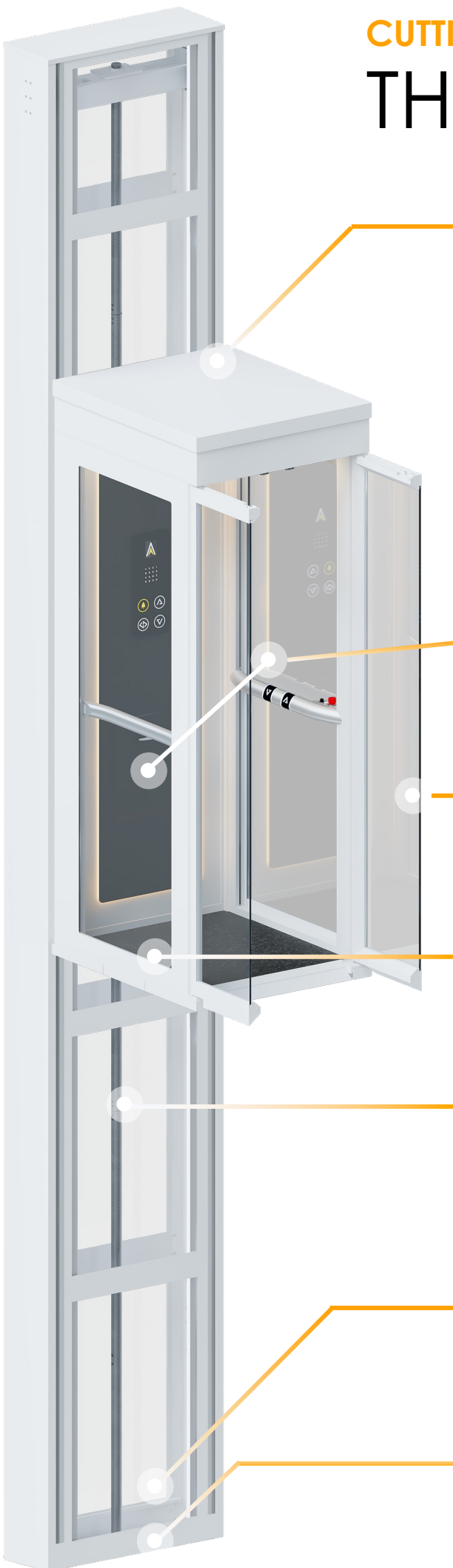

ABOUT ASCENDA

The Ascenda Minivator was created by the Cibes Lift Group with a simple mission: to provide accessibility to two-story homes at the highest safety standards.

The Ascenda not only conforms with both European and American safety standards, it also comes packed with safety features such

as redundant obstruction sensors and an emergency stop button.

But it doesn't stop there. When it comes to your home, looks matter, and our all glass (tempered and laminated!) design will fit right in. Whether you want it invisible in a corner or as a centerpiece, an Ascenda will always look fantastic!



OUR KEY DIFFERENCE FACTORY-DIRECT

In order to deliver the best value, we ensure that we control the entire value chain. With Ascenda, you are buying directly from the factory, no dealers and no middlemen involved!

Our factory-direct approach allows us to deliver most strongly on the two critical aspects of customer satisfaction: installation &

after-sales. By using our own locally trained technicians, we ensure a smooth installation in line with our exacting standards. Meanwhile, our direct presence ensures that, rain or shine, we will always be here to take care of you in terms of maintenance, warranty and repairs.



OUR FACTORY



OUR SHOWROOM



OUR INSTALLERS

THE NEW STANDARD

FULLY LOADED

At Ascenda, we believe in making the best elevator we can - and that means that our standard comes with all the stops, bells, whistles and more. Take a look at some of the key features included in your Ascenda Minivator.



AUTOMATIC SALOON DOORS

Fully automatic as standard, for a far more premium feel and better mobility



MIRROR CEILING WITH IN-BUILT FAN

Our mirror ceiling isn't just beautiful - it also holds a fan to provide a fresh breeze as you travel!

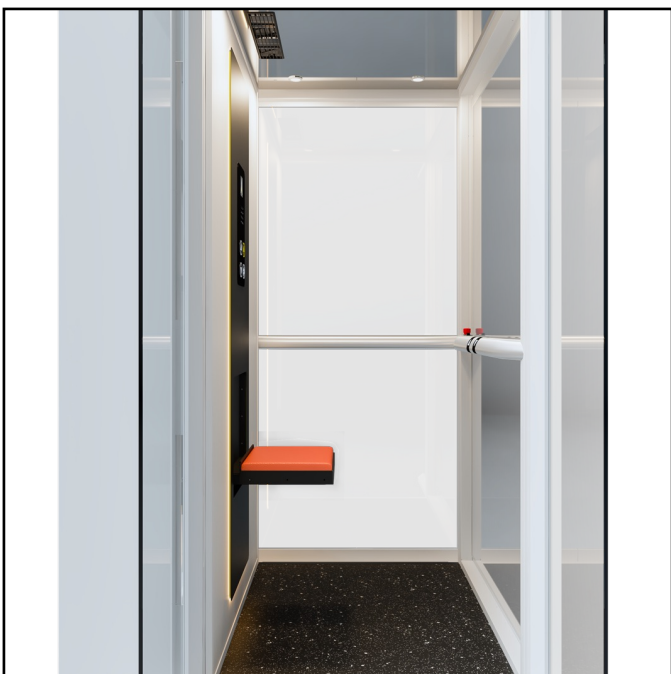

FOLD DOWN SEAT

Essential features should always be included - and that's why our foldable seat is standard.*

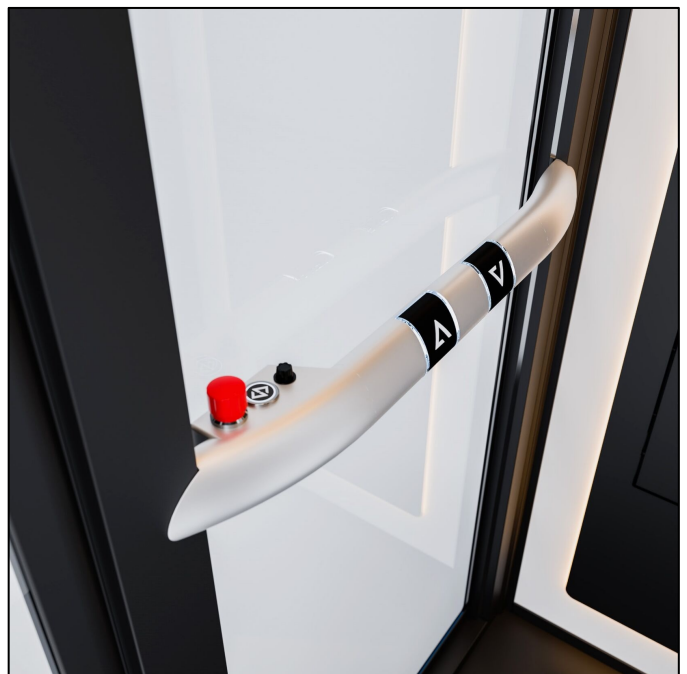

INTUITIVE HANDRAIL CONTROL

Perfect for wheelchairs or for when you sit down, the buttons built into the handrail come as standard.*

* Except on S Size where these features do not fit due to small size of cabin

FULLY LOADED

LIGHTING

Our guiderail lighting not only looks fantastic (wait until you use your elevator at night!) it also serves as a soft warning light that someone is about to come up or down.

ALL GLASS

Our mast and cabin both come in all glass as standard. Not only will it better fit in to your home design, but you get to enjoy the view on the way up!



CHOOSE BETWEEN
HATCH



CHOOSE BETWEEN
GATE



PERFECT FOR HOLD TO RUN

INTUITIVE DUAL CONTROL

Each Ascenda comes with dual control panels: one vertical and in a classic position, and the other built into the handrail itself. This allows passengers to control the elevator with ease, no matter which position they choose to travel in:

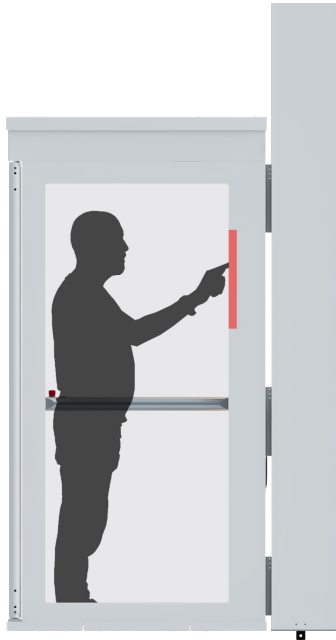

STANDING / TRADITIONAL COP

Just press the button on the main COP to move the elevator up and down, like you would on any other elevator



STANDING / HANDRAIL CONTROL

A much more comfortable way to travel: control the lift from the handrail and let the elevator take you to your chosen destination!

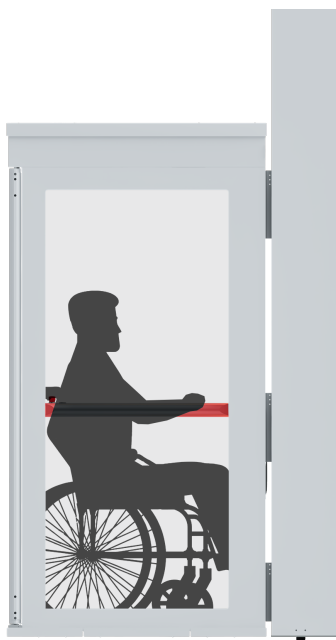

WHEELCHAIR / HANDRAIL CONTROL

The perfect solution for wheelchair users, as the Handrail Control is always within easy reach and is incredibly intuitive to use, even for the elderly!

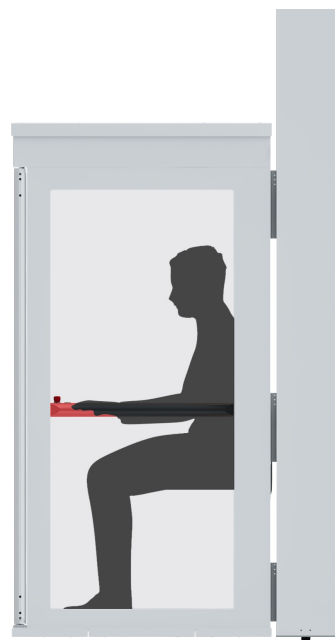

SITTING / HANDRAIL CONTROL

The Fold Down Seat is immensely practical, but not if you have to use Traditional Controls at the same time! That's where the Handrail Control comes in handy!

THERE'S AN
APP
FOR THAT!



AN ESSENTIAL SAFETY FEATURE

THE ASCENDA APP

- ▶ Monitor the elevator remotely and receive notifications in case of errors
- ▶ Call into the elevator's phone through the application to check on the passengers
- ▶ Check your elevator's info including Serial #, Maintenance
- ▶ Call your local Ascenda hotline through the application without having to look for the number
- ▶ ...and more!

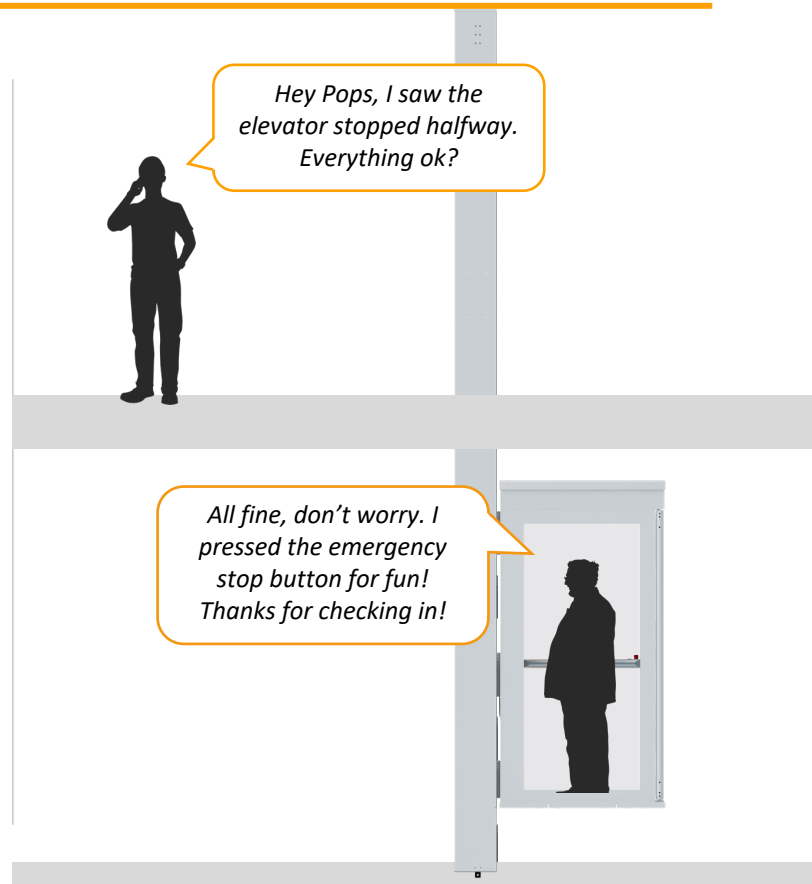

WHERE TO INSTALL?

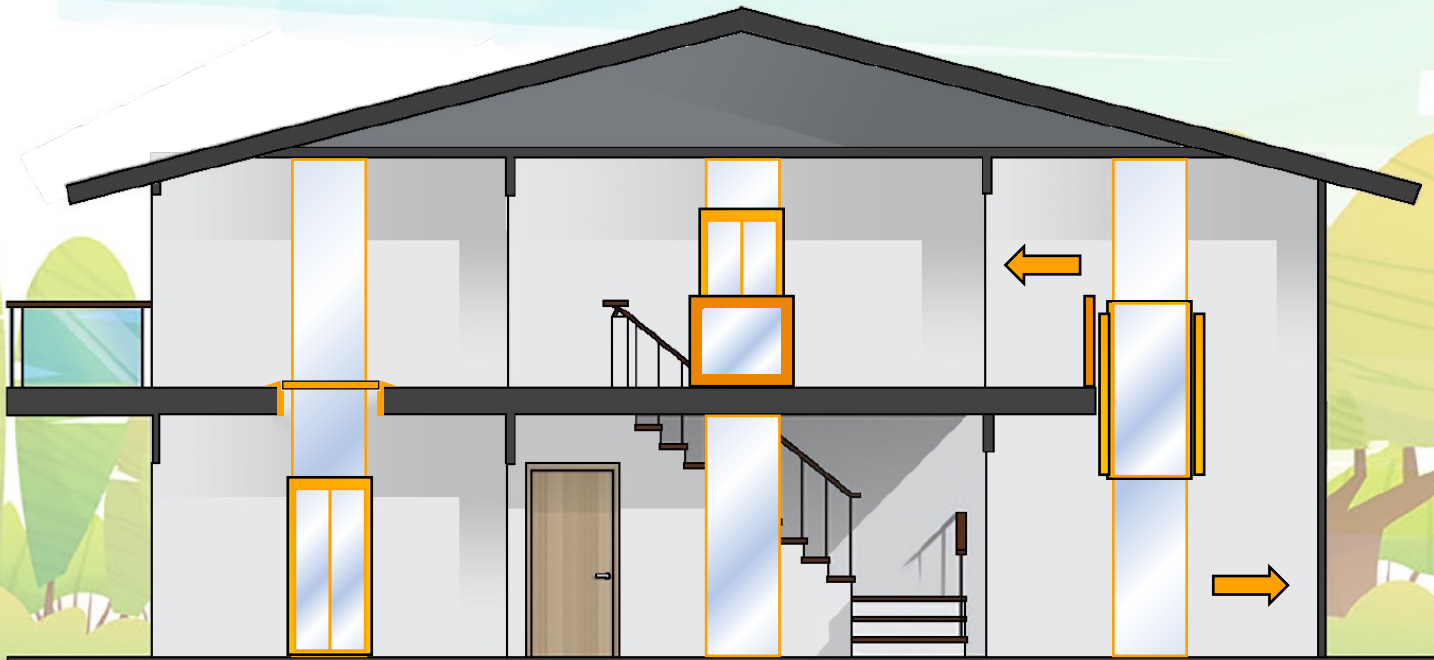

Through the Floor

Installed with a hatch system on second floor.

Middle of Stairs

Achieved with a gate system on the second step.

Open Through

With both a hatch or gate system possible.

OUR COMMITMENT

SAFETY FIRST



TOP SAFETY PAN



BOTTOM SAFETY PAN



EMERGENCY STOP BUTTON

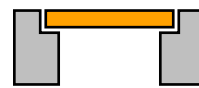

TOP FLOOR SAFETY LID PLUG



OVERSPEED MAX LIMIT

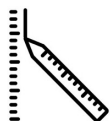

FINAL LIMIT SWITCH



EMERGENCY PHONE



FOR POWER CUTS BATTERY MODE



770 LBS WEIGHT LIMIT SENSOR

What is the Ascenda Minivator?

The Ascenda Minivator is a shaftless elevator designed for two-storey homes. It is extremely space-saving, incredibly safe and comes fully-loaded with standard features such as automatic saloon doors, a foldable seat and dual control for intuitive Hold to Run.

How does an Ascenda Run?

The Ascenda is a screw-driven elevator, meaning it is always attached to a toughened steel screw via a nut. As the nut rotates, it moves the elevator cabin up or down. This technology has the advantage of requiring no pit and no machine room while being both extremely silent and space-saving.

How much Space is Required ?

You can find all our sizes on the next page. Our smallest Ascenda requires less than 1 sqm!

Where can I Install an Ascenda?

Almost anywhere within your home! Against a wall, through the floor, within a closet or even in an existing void - our Ascenda is super flexible.

Can I use the Ascenda at Night?

The Ascenda is designed for use 24 hours a day, 7 days a week. At night, it is illuminated inside the cabin by the spotlights in the mirror ceiling. Additionally, it features lights that run the full length of the mast, illuminating the arrival area which both warns other house members of the elevator's arrival, and provides lighting when exiting the elevator.

What happens in case of a brown-out?

In case of a brown-out, the Ascenda will switch to Back-up Battery Mode. By pressing any button, the battery will bring the elevator to the lower landing, at which point the doors will open to let the passenger safely exit.

Is Ascenda Wheelchair Friendly?

The L and XL sizes are both wheelchair friendly. The L size is perfect for more compact wheelchairs, while the XL can fit almost any wheelchair thanks to its standing area of 850 x 1250 mm.

But it doesn't stop there - thanks to its handrail control, wheelchair users will find that moving up and down in an Ascenda is easy and intuitive as the buttons are extremely accessible.

Do I Have to Hold it to Run?

The Ascenda is in autorun, meaning you can press the button once to get to your desired floor.

However, you may choose to keep pressing on the button thanks to our innovative handrail control, which has buttons integrated for ease of use!

What does "Fully Loaded" mean?

In the home elevator industry, the traditional business model is to offer a cheap, ultra standard elevator and to charge heavily for any option.

At Ascenda, we believe that every home deserves the best possible elevator, and that is why we offer our key features as standard. Full glass mast? Included. Automatic saloon doors? Included. Dual control? Included.

No sneaky upsell, no tricky additional fees - with Ascenda, our elevators are **fully loaded as standard!**

Is an Ascenda Safe?

The Ascenda is certified according to both USA safety standards (ASME 17.1 Section 5.3) and European safety standards (EN81-41 with parts of EN81-20), making it among the safest elevators on the market.

It also comes packed with safety features such as safety sensors in the floor, hatch and cabin roof, emergency stop button, two-way phone with app-linked notifications in case of faults, emergency battery back up and more!

What are the Power Requirements?

An Ascenda runs on one phase power (1 x 230V), meaning it can operate on any normal power source within the home.

What about Construction Work?

The construction work required is minimal, and usually only consists of cutting the appropriate rectangular hole in the floor.

What about Fixing Points?

We fix the Ascenda Minivator in three points: on the ground, on the slab or floor beams, and at the top. You can always ask your Ascenda Certified Technician for more details as, even in tough situations, we have flexible solutions such as extending guiderails.

Can it be Installed Outdoor?

Unfortunately, the Ascenda is not yet available for Outdoor usage, and is limited to Indoor installations.

What Happens if Someone is Standing on the Hatch as the Ascenda is Coming Up? What about if someone is Below as it is coming down?

This is where all the Ascenda's safety systems come into play. If anything above 10 kg is on the hatch, the Ascenda Minivator will stop, and will only be able to move downwards (to the ground floor) until the object or person is removed from the hatch.

Similarly, if the Ascenda is going downward and the lower safety pan comes into contact with a person or object, the elevator will automatically stop and will only be able to move upwards until the obstruction is cleared.

TECHNICAL SPECIFICATIONS

A PERFECT SIZE...

S
SIZE



Available in:

- White (*standard*)
- Black (*optional*)

Can fit :



| | |
|-----------------------|------------|
| STANDING SPACE | 700 x 600 |
| FINISHED SIZE | 818 x 1059 |
| HATCH CUT-OUT | 930 x 1132 |
| DOOR OPENING | 696 |

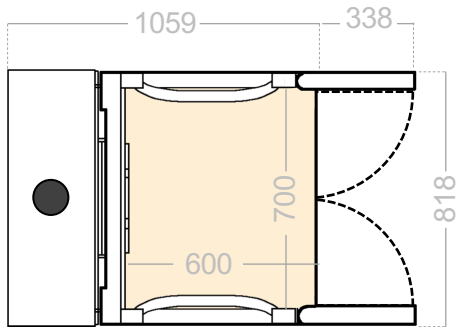

M
SIZE



Available in:

- White (*standard*)
- Black (*optional*)

Can fit :



| | |
|-----------------------|------------|
| STANDING SPACE | 700 x 800 |
| FINISHED SIZE | 818 x 1259 |
| HATCH CUT-OUT | 930 x 1332 |
| DOOR OPENING | 696 |

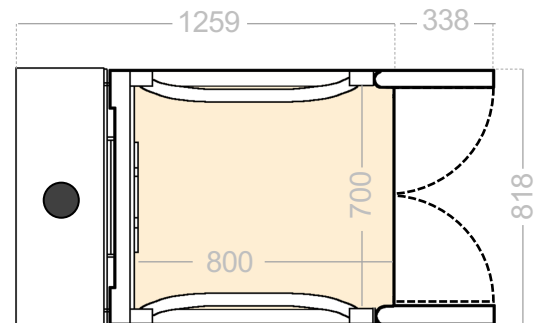

TECHNICAL SPECIFICATIONS

| | |
|------------------------------|-------------------------|
| Drive | Screw-Drive |
| Screw Type | Trapezoidal, 24 mm |
| Drive Type | EcoSilent 2.0 |
| Motor | PMSM UltraQuiet |
| Motor Power | 2.7 kW |
| Landing Call Stations | 2 Wireless Remotes |
| Lighting Type | Automatic EcoSaving LED |

| | |
|----------------------|------------------------|
| Door Type | Fully Automatic Saloon |
| Maximum Load | 350 kg |
| Maximum Speed | 0.15 m/s |
| Operation | Autorun |
| Glass Type | Tempered & Laminated |
| Maintenance | 1 x per year |
| Warranty | 2 years |

TECHNICAL SPECIFICATIONS

...FOR EVERY NEED

L
SIZE

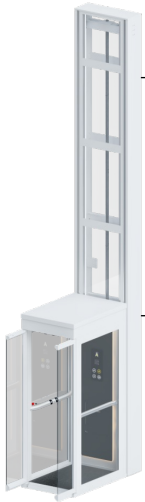

Available in:

- White (standard)
- Black (optional)

Can fit :



XL
SIZE



Available in:

- White (standard)
- Black (optional)

Can fit :



STANDING SPACE 700 x 1000

FINISHED SIZE 818 x 1459

HATCH CUT-OUT 930 x 1532

DOOR OPENING 696

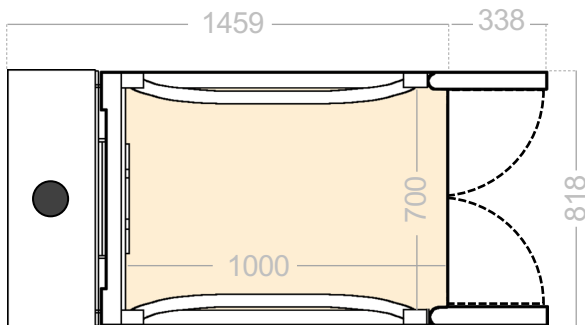

STANDING SPACE 1250 x 850

FINISHED SIZE 1382 x 1300

HATCH CUT-OUT 1488 x 1375

DOOR OPENING 825

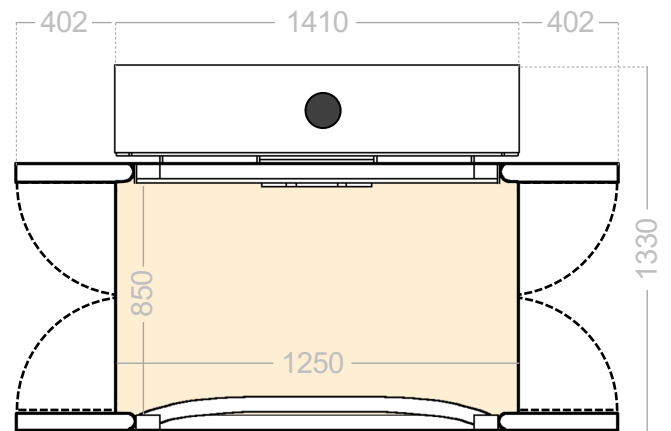

TECHNICAL SPECIFICATIONS

Power Supply 240V, 60 Hz

Pit 0 mm

Overhead 2300 mm

Maximum Travel 3800 mm

Door Height Clearance 2050 mm

Power Cut Rescue Emergency Battery

Manual Lowering System At bottom of mast

WIRELESS REMOTES



OUR KEY DIFFERENCE

EXCEPTIONAL AFTER-SALES



THE FACTORY-DIRECT AFTER-SALES PROMISE

Cibes Lift India Pvt. Ltd. knows that the secret to its phenomenal success has been its best-in-class after-sales service. Over 35% of our business comes from referrals. This is because Cibes has focused on a factory-direct strategy for its technical team as well:

- **NO OUTSOURCING!**
- **TECHNICIANS TRAINED FROM SWEDEN**
- **LOCAL SPARE PARTS WAREHOUSE**

OUR AFTERSALES IN INDIA



Rahul



Anoop



Chandrashekhar



Pradeep



Dharpal



Pintu



Sumit



Abhishek



SHOWROOMS & TECHNICAL STATIONS



GURUGRAM



BENGALURU



KOLKATA

**NATIONWIDE
COVERAGE**

ASCENDA

by **Cibās**

